

TMAX-1335-XXX-M Molded Power Inductor

Features

-
-
-
-
-
-

Applications

-
-
-
-
-
-

Product Description

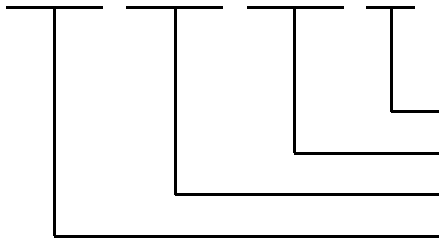

Dimensions

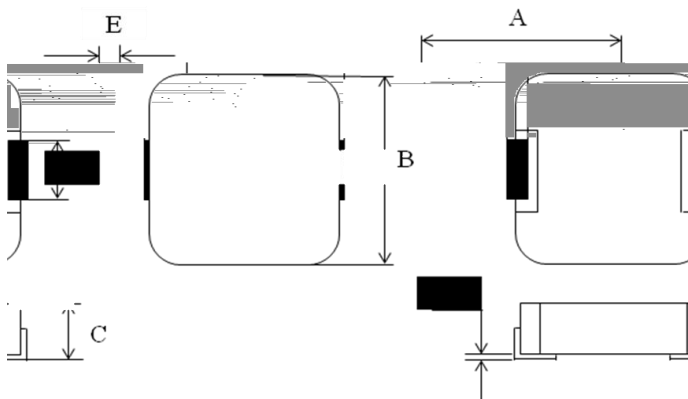

	13.8Max
	12.7±0.2
	3.5 Max.
	3.7±0.5
	2.3±0.5
	0~0.20

Recommend Land Pattern Dimensions

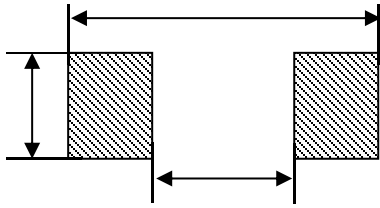

Marking

-
-

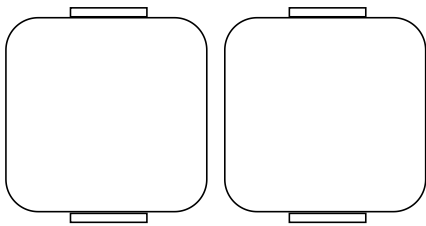

Specifications

Part No.	Inductance		DCR (mΩ)		Saturation Current	Heat Rating Current
					Isat (Amps.)	Idc (Amps.)
	μ					

Notes:

Inductance and Temperature Rise vs. DC Current

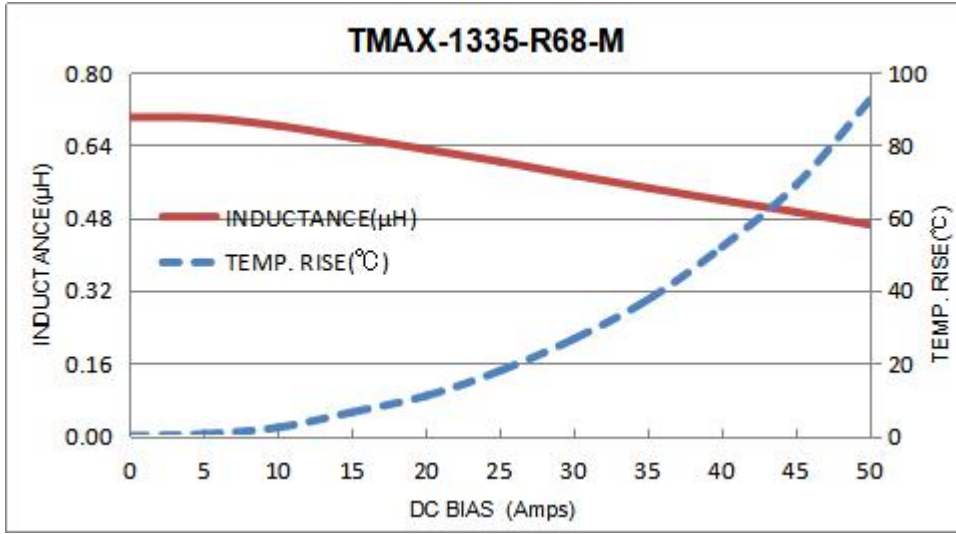

Reliability:

Item

Test Method

Specification and Requirement

±

±

±



TDG HOLDING CO., LTD.
天通控股股份有限公司

Reliability:

Item	Test Method	Specification and Requirement
	\pm \pm \rightarrow \rightarrow \pm \pm \rightarrow	\pm
	\pm	
	\pm	
	\pm	
	\pm	

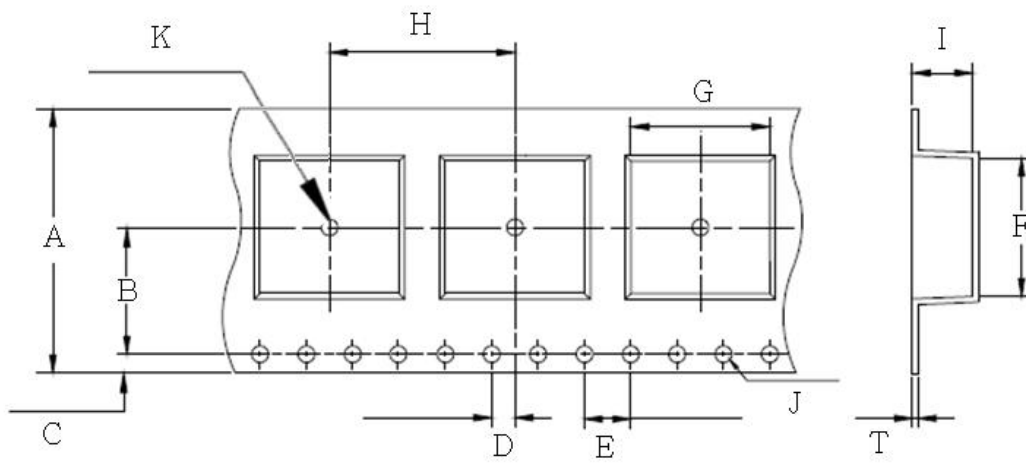
Packaging Dimensions

Peeling of top cover tape

-
-

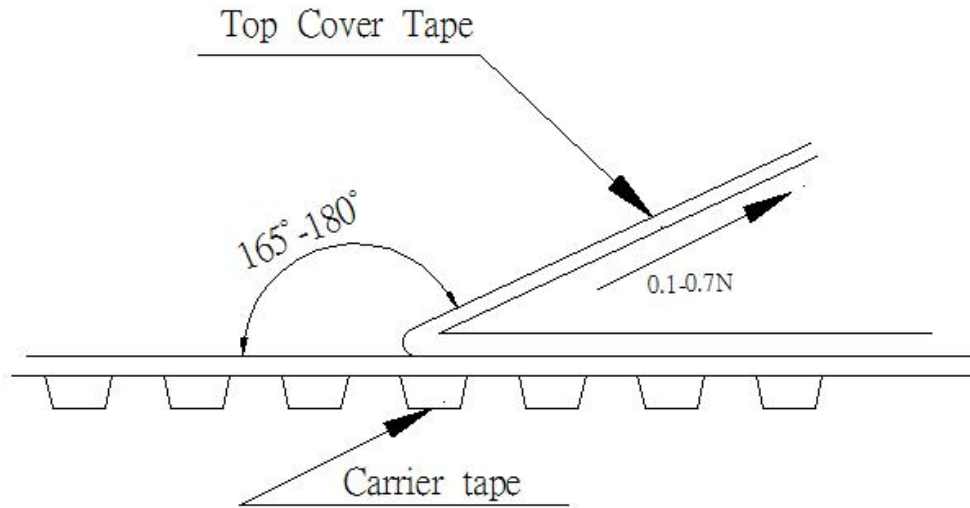



Numbers of taping

-

Label marking

-
-

Production Label

- ✓
- ✓
- ✓
- ✓
- ✓

Shipping Label

- ✓
- ✓
- ✓
- ✓
- ✓

Care note for use

- **Storage Condition**

- **Use Temperature**

- ✓
- ✓

- ✓
- ✓

- **Model**

- **Drop**



Care note for Safety

